

ARTICULO: 2401

Válvula de Retención tipo wafer de doble disco. Check Valve (double disk) wafer type.

Características

1. Válvula de retención doble disco tipo wafer.
2. Construcción en Fundición GG-25.
3. Disco en Acero Inoxidable CF8M.
4. Eje y resorte en Acero Inoxidable AISI 316.
5. Asiento Nitrilo (NBR) vulcanizado en ranura.
6. Montaje entre bridas DIN PN-10/16.
7. Instalación Horizontal , Vertical o Inclinada.
8. Longitud entre caras según EN 558-1.
9. Presión de trabajo máxima 16 Kg / cm².
10. Temperatura de Trabajo máxima 100 °C.

Features

1. Wafer check valve (double disk).
2. Made of Cast Iron GG-25.
3. Disk made of CF8M.
4. Axle and spring made of AISI 316.
5. Seat of NBR vulcanised in groove.
6. Assembly between flanges DIN PN-10/16.
7. Installed with vertical , horizontal or inclined flow.
8. Face to Face according EN 558-1.
9. Max. Working pressure 16 Kg / cm².
10. Max. Working temperature 100 °C.

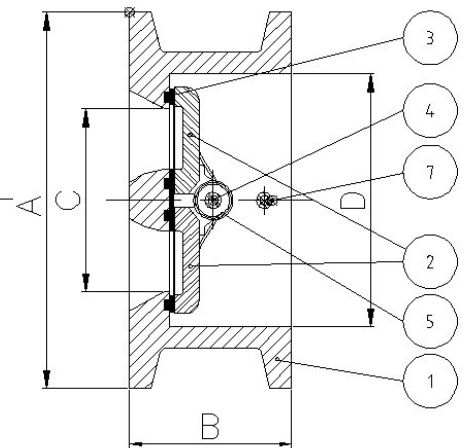
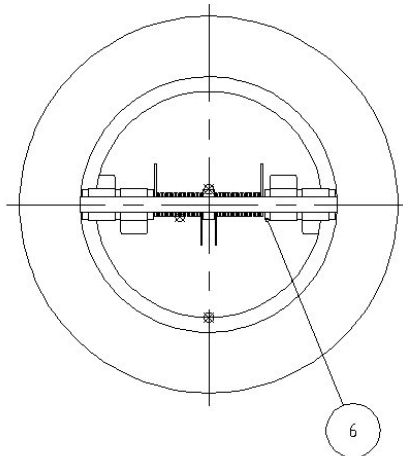

Nº	Denominación/Name	Material	Acabado Superficial/Surface Treatment
1	Cuerpo / Body	Hierro Fundido GG-25 / Cast Iron GG-25	Pintura Epoxi / Epoxi Painted
2	Disco / Disk	Acero Inox AISI 316 / SS 316	-----
3	Asiento / Seat	NBR	-----
4	Eje / Axle	Acero Inox AISI 316 / SS 316	-----
5	Resorte / Spring	Acero Inox AISI 316 / SS 316	-----
6	Arandela / Washer	Teflón / PTFE	-----
7	Tope Disco / Disk Stopper	Acero Inox AISI 316 / SS 316	-----

DIMENSIONES GENERALES / GENERAL DIMENSIONS



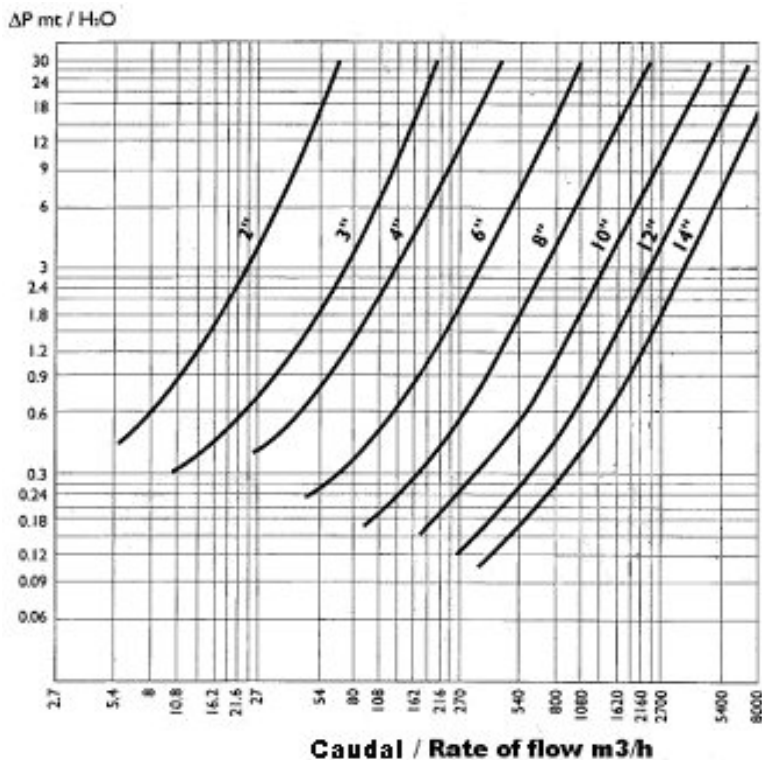

Ref	Medida/Size	DN	PN	Dimensiones/Dimensions (mm)				Peso/Weight (Kg)
				A	B	C	D	
2401 09	2 "	50	16	109	54	44	66	1.850
2401 10	2 1/2 "	65	16	129	54	54	78	2.450
2401 11	3 "	80	16	144	57	68	89	3.100
2401 12	4 "	100	16	164	64	86	117	4.650
2401 13	5 "	125	16	194	70	108	141	6.900
2401 14	6 "	150	16	220	76	132	168	9.100
2401 16	8 "	200	16	275	95	180	210	14.500
2401 18	10 "	250	16	330	108	224	233	24.650
2401 20	12 "	300	16	380	143	262	311	39.950

DIAGRAMA DE PERDIDAS DE CARGA / HEAD LOSSES DIAGRAM

(H₂O – 20 °C Flujo Horizontal / Horizontal flow).



MÍNIMA PRESION DE APERTURA / MINIMUN OPENING PRESSURE

FLUJO / FLOW	Aplicación Aplication	Presion Pressure	2"	2 1/2"	3"	4"	5"	6"	8"	10"	12"
	con muelle / with spring	mbar	22,8	22,8	22,8	24	24,5	24,7	25,4	26,6	27,3
	con muelle / with spring	mbar	22,4	22,4	22,4	23,5	24	24,1	24,7	25,8	26,4
	con muelle / with spring	mbar	22	22	22	23	23,5	23,5	24	25	25,5
	sin muelle / without spring	mbar	0,4	0,4	0,4	0,5	0,5	0,6	0,7	0,8	0,9